

ATF 100G-4

110 TON CAPACITY

**ALL
TERRAIN
CRANE**



Dimensions (ft, mm) / Dimensiones (ft, mm)



445/95 R 25
(16.00 R 25)

SAE

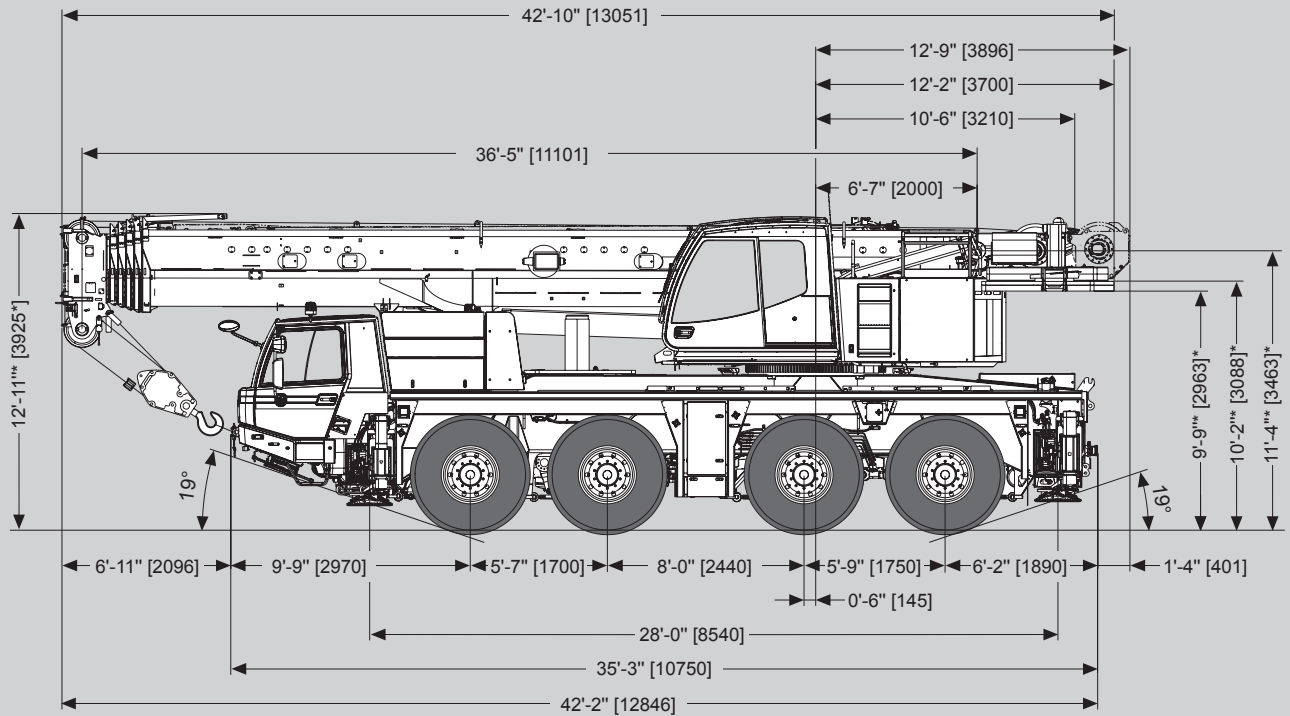

* ± 0'-4" [100]

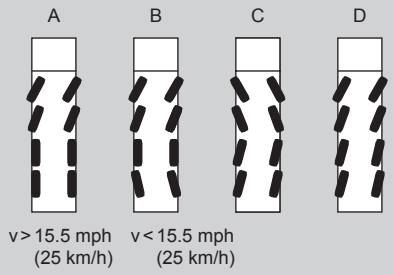
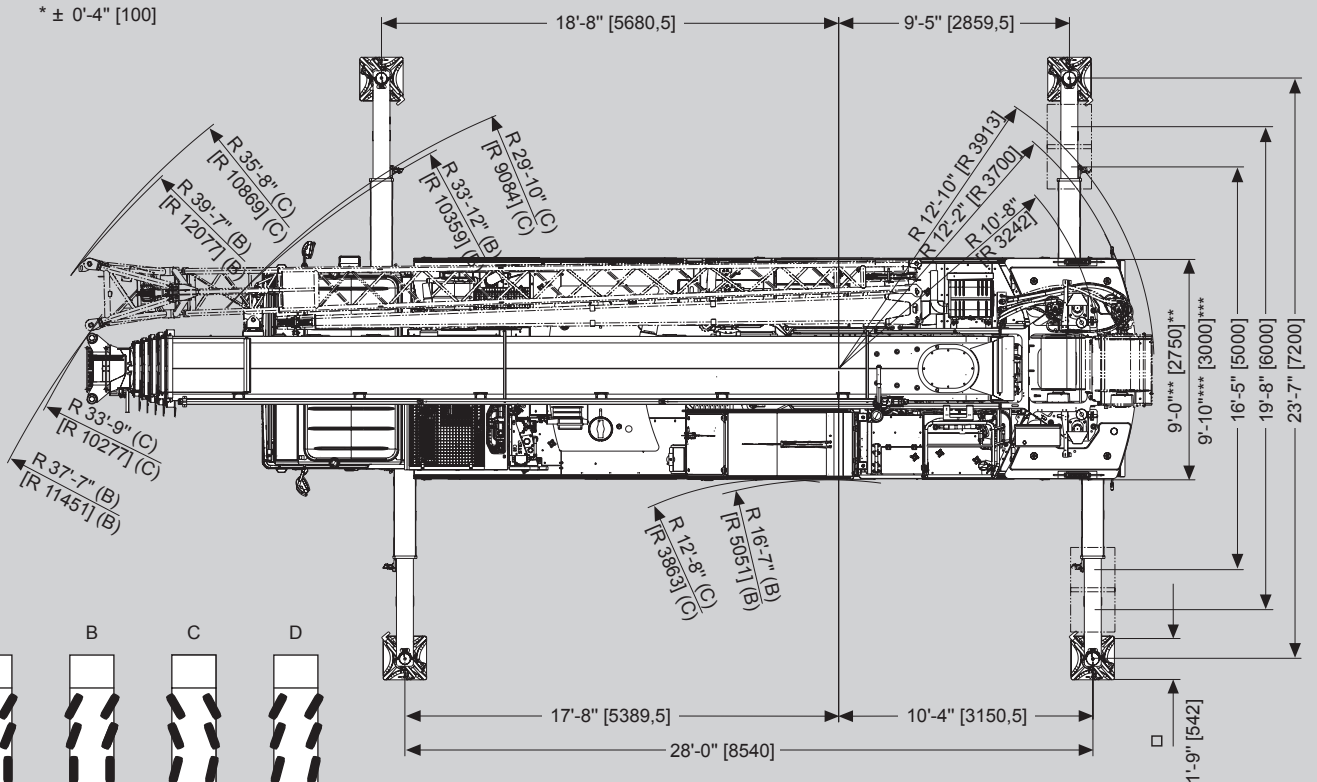













** 445/95 R 25 (16.00 R25)
*** 525/80 R 25 (20.50 R25)

Weights / Working speeds / Pesos / Velocidades de trabajo

 * Rams horn * Gancho doble	Lifting capacity Capacidad de elevación [lbs]	Sheaves Poleas	Part of line Ramales de cable	Weight Peso [lbs]
		130,293 (Type / Typo 63 ton)*	5	11
	83,996 (Type / Typo 40 ton)*	3	7	1,212
	83,996 (Type / Typo 40 ton)	3	7	1,212
	36,376 (Type / Typo 20 ton)	1	3	661
	12,350 (Type / Typo 6 ton)	-	1	331

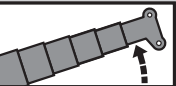
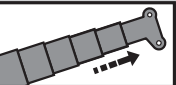

 395/95 (14.00) mph	 	1	2	3	4	5	6	7	8	9	10	11	12	R1	R2	 74%
				1.9	2.5	3.1	3.7	5.0	6.2	8.1	10.6	13.7	17.4	22.4	28.6	
 445/95 (16.00) mph	 	1.9	2.5	3.1	4.3	5.6	6.8	9.3	11.8	14.9	19.3	24.2	31.1	1.9	2.5	65%
				3.7	5.0	6.2	8.1	9.9	12.4	16.8	21.1	27.3	35.4	44.7	52.8	

V+ 	Infinitely variable Infinitamente variable	Rope (diameter/length) Cable (diámetro/longitud)	Max. single line pull Trio máximo por ramal
	0 - 377 ft/min 0 - 115 m/min single line ramal simple	0.70"/ 755' 18 mm / 230 m	12,364 lbs 55 kN
	0 - 377 ft/min 0 - 115 m/min single line ramal simple	0.70"/ 755' 18 mm / 230 m	12,364 lbs 55 kN
	Max. permissible line pull may be affected by wire rope strength. which should not exceed 12.350 lbs for main winch and auxiliary winch La fuerza max del cabestrante es dependiente de la normativa en vigor. la cual no permite superar los 55 kN de fuerza.		
	0 - 2 rpm	 0° + 180°	
	-1.0° - +82.4°	approx. 30 s aproximadamente 30 s	
	36.4 ft - 168.0 ft 11.1 m - 51.2 m	approx. 310 s aproximadamente 310 s	

Lifting heights / Alturas de elevación

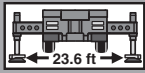
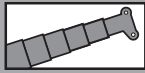

49,604 lbs

lbs x 1,000

SAE

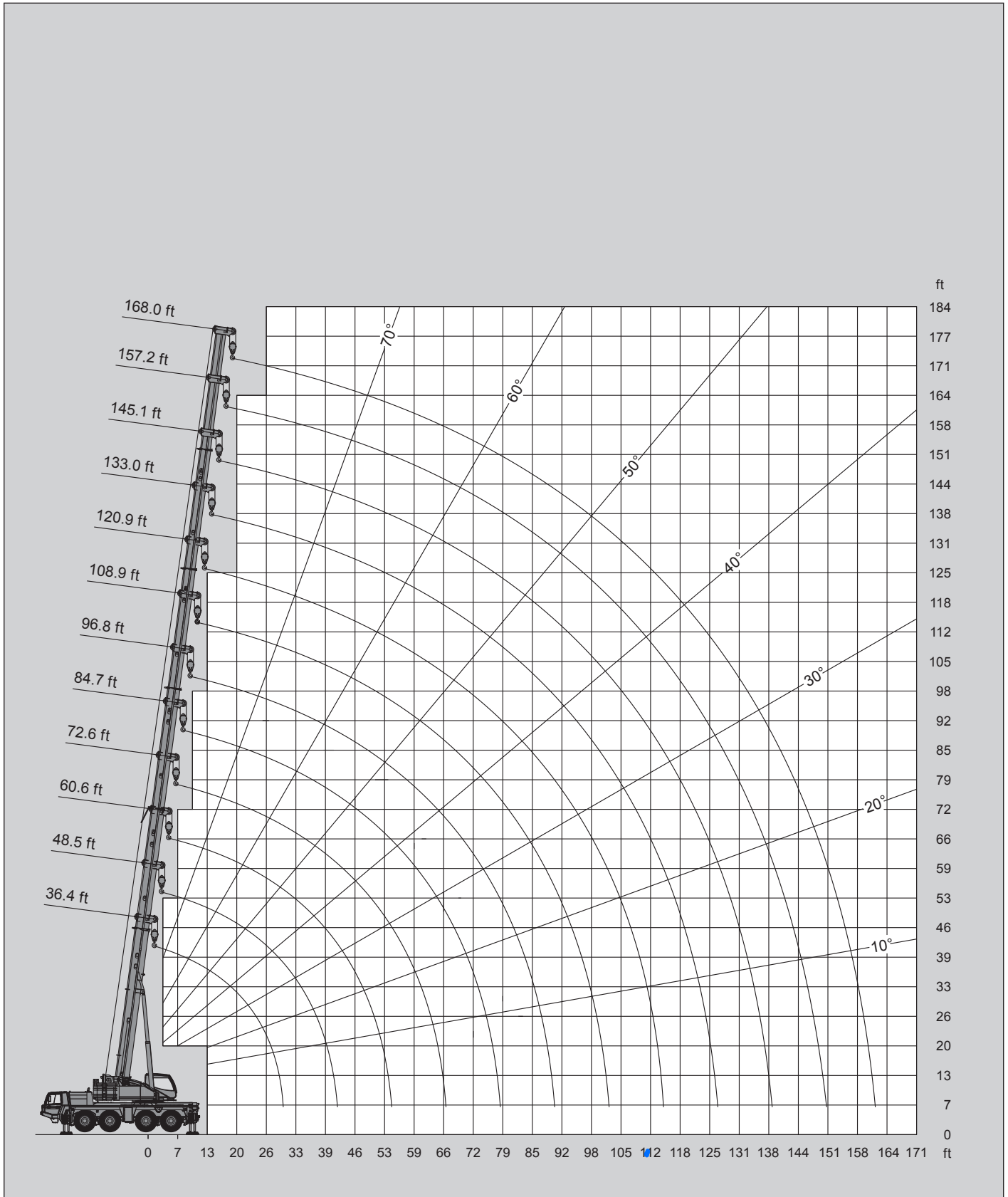



			49,604 lbs	lbs x 1,000	SAE
---	---	---	-------------------	-------------	------------

 ft	36.4 ft*	36.4 ft	48.5 ft	60.6 ft	72.6 ft	84.7 ft	96.8 ft	108.9 ft	120.9 ft	133.0 ft	145.1 ft	157.2 ft	168.0 ft
7.5	220.5**												
8	198.4**												
10	179.9**	167.8**	143.3	143.3									
12	164.5	154.1	143.3	143.3	110.2								
13	150.6	141.3	140.0	135.4	110.2	91.0							
15	138.2	130.1	129.0	125.0	110.2	91.0							
16	127.4	120.4	119.0	116.2	110.2	86.4	69.7						
20	110.2	104.1	102.7	103.2	101.2	76.9	69.7	52.5					
23	93.7	90.8	89.7	89.9	89.9	72.8	63.7	52.5	43.4	34.8			
26	80.7	78.3	78.0	78.3	78.9	68.6	62.8	52.5	43.4	34.8	28.4		
30	54.9	52.9	68.8	69.2	69.7	64.8	62.8	49.8	43.4	34.8	28.4	22.5	
33			61.3	61.7	62.2	61.7	62.8	46.1	43.2	34.8	28.4	22.5	19.6
36			52.5	52.7	54.5	57.1	56.2	42.8	40.1	34.8	28.4	22.5	19.6
39			45.4	49.2	50.5	49.8	48.9	39.7	37.5	34.8	28.4	22.5	19.6
46				39.7	39.7	39.2	38.4	35.7	32.8	31.1	28.4	22.5	19.6
53				32.2	32.4	32.0	31.1	32.2	29.1	27.8	26.0	22.5	19.6
59					27.1	26.7	25.8	26.9	25.8	24.9	23.8	22.0	19.6
66					21.2	22.7	21.8	22.7	23.1	21.4	21.6	20.1	18.7
72						19.4	18.7	19.6	19.8	19.2	19.6	18.5	16.8
79							17.2	17.0	17.4	17.4	17.2	16.5	15.2
85							16.1	14.8	15.9	15.4	15.0	14.3	13.7
92								13.4	14.1	13.4	13.2	12.6	12.3
98								12.6	12.6	12.1	11.7	11.0	11.0
105									11.2	10.6	10.4	9.5	9.5
112									10.1	9.5	9.0	8.4	8.4
118										8.4	7.9	7.3	7.3
125										7.5	7.1	6.4	6.2
131											6.2	5.5	5.5
138											5.5	4.6	4.6
144												4.0	4.0
151													3.3
158													2.9

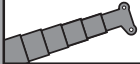
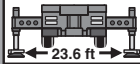

* Over rear / * Sobre la parte trasera ** With additional lifting equipment / ** Con equipo adicional

Lifting capacities / Capacidades de elevación

			35,935 lbs	lbs x 1,000	SAE
---	---	---	-------------------	-------------	------------

 ft	36.4 ft*	36.4 ft	48.5 ft	60.6 ft	72.6 ft	84.7 ft	96.8 ft	108.9 ft	120.9 ft	133.0 ft	145.1 ft	157.2 ft	168.0 ft
7.5	220.5**												
8	198.4**												
10	179.9**	168.2**	143.3	143.3									
12	163.1	153.0	143.3	143.3	110.2								
13	148.8	140.0	138.9	135.4	110.2	91.0							
15	136.5	128.5	127.4	125.0	110.2	91.0							
16	125.9	118.6	117.5	116.2	110.2	86.4	69.7						
20	105.6	102.3	101.2	101.4	101.2	76.9	69.7	52.5					
23	89.1	87.5	86.4	86.6	87.3	72.8	63.7	52.5	43.4	34.8			
26	76.1	76.3	75.2	75.4	76.1	68.6	62.8	52.5	43.4	34.8	28.4		
30	54.9	52.9	62.4	62.8	63.7	64.8	62.8	49.8	43.4	34.8	28.4	22.5	
33			51.8	54.5	57.5	56.9	56.0	46.1	43.2	34.8	28.4	22.5	19.6
36			46.1	49.2	49.4	48.7	47.8	42.8	40.1	34.8	28.4	22.5	19.6
39			41.7	42.8	43.0	42.3	41.4	39.7	37.5	34.8	28.4	22.5	19.6
46				33.7	33.7	33.3	32.4	33.5	31.5	31.1	28.4	22.5	19.6
53				27.3	27.3	26.9	26.0	27.1	27.6	25.6	26.0	22.5	19.6
59					23.8	22.3	22.3	22.3	22.9	22.7	22.7	22.0	19.6
66					20.3	19.6	20.3	18.7	20.1	19.4	19.2	18.5	18.5
72						17.4	17.4	17.0	17.2	16.5	16.3	15.7	15.7
79							15.2	15.0	14.8	14.3	14.1	13.4	13.4
85							13.4	13.0	13.0	12.3	12.1	11.5	11.5
92								11.5	11.5	10.8	10.4	9.7	9.7
98								10.1	9.9	9.3	9.0	8.2	8.2
105									8.8	8.2	7.7	6.8	6.8
112									7.7	7.1	6.6	6.0	5.7
118										6.2	5.7	4.9	4.9
125										5.3	4.9	4.0	4.0
131											4.2	3.3	3.3
138											3.5	2.6	2.6
144												2.0	2.0
151													1.5

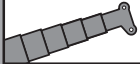
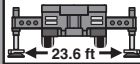

* Over rear / * Sobre la parte trasera ** With additional lifting equipment / ** Con equipo adicional

			22,487 lbs	lbs x 1,000	SAE
---	---	---	-------------------	-------------	------------

	 ft	36.4 ft*	36.4 ft	48.5 ft	60.6 ft	72.6 ft	84.7 ft	96.8 ft	108.9 ft	120.9 ft	133.0 ft	145.1 ft	157.2 ft	168.0 ft
7.5		220.5**												
8		198.4**												
10		178.6**	166.9**	143.3	143.3									
12		161.4	151.7	143.3	143.3	110.2								
13		147.0	138.2	137.3	135.4	110.2	91.0							
15		134.9	127.0	125.9	125.0	110.2	91.0							
16		122.4	117.1	116.0	115.1	110.2	86.4	69.7						
20		100.3	98.5	97.4	97.7	97.0	76.9	69.7	52.5					
23		81.6	84.4	82.7	81.6	78.0	72.8	63.7	52.5	43.4	34.8			
26		63.1	65.9	63.7	64.4	65.7	66.4	62.2	52.5	43.4	34.8	28.4		
30		50.9	52.9	51.6	57.1	57.3	56.7	53.4	49.8	43.4	34.8	28.4	22.5	
33				46.7	47.8	48.1	47.4	46.3	43.7	41.9	34.8	28.4	22.5	19.6
36				39.7	40.8	41.0	40.3	39.5	40.8	37.0	34.8	28.4	22.5	19.6
39				34.4	35.5	35.5	35.1	34.2	35.3	34.0	32.2	28.4	22.5	19.6
46					27.6	28.9	27.1	27.6	27.3	28.0	26.9	25.8	22.5	19.6
53					22.3	23.1	23.4	23.6	22.7	23.1	22.5	22.3	21.4	19.6
59						19.2	19.2	19.4	19.0	19.0	18.3	18.1	17.4	17.2
66						16.1	16.1	16.1	15.9	15.9	15.2	15.0	14.1	14.1
72							13.7	13.7	13.4	13.2	12.8	12.3	11.7	11.7
79								11.7	11.5	11.2	10.8	10.4	9.7	9.7
85								10.1	9.7	9.7	9.0	8.6	7.9	7.9
92									8.4	8.2	7.5	7.3	6.4	6.4
98									7.3	7.1	6.4	6.0	5.3	5.3
105										6.0	5.3	4.9	4.2	4.2
112										5.1	4.4	4.0	3.3	3.3
118											3.7	3.3	2.4	2.4
125											3.1	2.6	1.8	1.8
131												2.0	1.1	1.1
138												1.3		

* Over rear / * Sobre la parte trasera ** With additional lifting equipment / ** Con equipo adicional

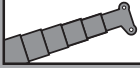
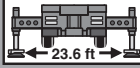
Lifting capacities / Capacidades de elevación

16,755 lbs

lbs x 1,000 **SAE**

 ft	36.4 ft*	36.4 ft	48.5 ft	60.6 ft	72.6 ft	84.7 ft	96.8 ft	108.9 ft	120.9 ft	133.0 ft	145.1 ft	157.2 ft	168.0 ft
7.5	220.5**												
8	198.4**												
10	177.7**	166.2**	143.3	143.3									
12	160.5	151.0	143.3	143.3	110.2								
13	146.2	137.6	136.5	135.4	110.2	91.0							
15	134.0	126.1	125.0	124.3	110.2	91.0							
16	119.5	115.7	114.4	113.5	110.2	86.4	69.7						
20	97.9	97.0	95.7	94.1	89.3	76.9	69.7	52.5					
23	74.7	77.8	75.6	74.7	71.6	72.8	63.7	52.5	43.4	34.8			
26	57.5	60.2	58.2	61.5	64.6	61.1	57.1	52.5	43.4	34.8	28.4		
30	46.3	48.7	51.1	52.5	52.5	51.8	48.9	45.9	43.4	34.8	28.4	22.5	
33			42.5	43.9	43.9	43.2	42.3	42.3	38.1	34.8	28.4	22.5	19.6
36			36.2	37.3	37.5	36.8	35.9	37.0	35.5	32.6	28.4	22.5	19.6
39			31.3	32.4	32.4	32.0	31.3	32.2	32.6	28.9	28.4	22.5	19.6
46				24.9	26.0	26.2	26.2	25.6	26.0	25.4	24.3	22.5	19.6
53				19.8	20.7	20.7	20.9	20.7	20.7	20.1	19.6	18.7	18.3
59					17.0	17.0	17.2	17.0	16.8	16.1	15.9	15.2	15.2
66					14.1	14.1	14.3	13.9	13.9	13.2	13.0	12.3	12.3
72						11.9	12.1	11.7	11.7	11.0	10.8	9.9	9.9
79							10.1	9.9	9.7	9.0	8.8	7.9	7.9
85							8.8	8.4	8.2	7.5	7.3	6.4	6.4
92								7.1	6.8	6.2	6.0	5.1	5.1
98								6.0	5.7	5.1	4.6	4.0	4.0
105									4.9	4.2	3.7	3.1	3.1
112									4.0	3.3	2.9	2.2	2.2
118										2.6	2.2	1.5	1.3
125										2.0	1.5		

* Over rear / * Sobre la parte trasera ** With additional lifting equipment / ** Con equipo adicional





13,228 lbs

lbs x 1,000 **SAE**

 ft	36.4 ft*	36.4 ft	48.5 ft	60.6 ft	72.6 ft	84.7 ft	96.8 ft	108.9 ft	120.9 ft	133.0 ft	145.1 ft	157.2 ft	168.0 ft
7.5	220.5**												
8	198.4**												
10	177.0**	166.0**	143.3	143.3									
12	160.1	150.4	143.3	143.3	110.2								
13	145.7	137.1	136.0	135.4	110.2	91.0							
15	132.1	125.7	124.6	123.7	110.2	91.0							
16	117.9	114.6	113.3	112.2	110.0	86.4	69.7						
20	96.6	95.9	94.6	89.1	84.4	76.9	69.7	52.5					
23	70.3	73.4	71.2	70.5	70.1	68.8	62.8	52.5	43.4	34.8			
26	54.2	56.9	55.3	61.1	61.1	57.8	53.8	50.3	43.4	34.8	28.4		
30	43.4	45.6	48.3	49.6	49.6	48.9	46.1	45.6	41.2	34.8	28.4	22.5	
33			40.1	41.2	41.4	40.8	39.9	39.9	35.5	34.6	28.4	22.5	19.6
36			34.0	35.3	35.3	34.6	33.7	34.8	34.4	30.2	28.4	22.5	19.6
39			29.1	30.2	31.5	30.0	31.3	30.0	30.4	28.4	26.5	22.5	19.6
46				23.1	24.3	24.3	24.5	24.3	23.4	23.4	22.7	21.2	19.6
53				18.3	19.2	19.2	19.4	19.2	19.2	18.5	18.1	17.2	16.8
59					15.7	15.7	15.9	15.7	15.4	14.8	14.6	13.9	13.9
66					13.0	13.0	13.0	12.8	12.8	12.1	11.9	11.0	11.0
72						10.8	11.0	10.6	10.6	9.9	9.7	8.8	8.8
79							9.3	8.8	8.8	8.2	7.7	7.1	7.1
85							7.7	7.5	7.3	6.6	6.2	5.5	5.5
92								6.2	6.0	5.3	5.1	4.2	4.2
98								5.1	4.9	4.4	4.0	3.1	3.1
105									4.0	3.5	3.1	2.2	2.2
112									3.3	2.6	2.2	1.5	1.5
118										2.0	1.5		
125										1.5			

* Over rear / * Sobre la parte trasera ** With additional lifting equipment / ** Con equipo adicional





11,243 lbs

lbs x 1,000 **SAE**

 ft	36.4 ft*	36.4 ft	48.5 ft	60.6 ft	72.6 ft	84.7 ft	96.8 ft	108.9 ft	120.9 ft	133.0 ft	145.1 ft	157.2 ft	168.0 ft
7.5	220.5**												
8	198.4**												
10	176.8**	165.8**	143.3	143.3									
12	159.6	150.1	143.3	143.3	110.2								
13	145.5	136.9	135.8	134.9	110.2	91.0							
15	131.0	125.4	124.3	123.5	110.2	91.0							
16	117.1	114.0	112.7	111.6	106.7	86.4	69.7						
20	94.4	95.2	92.6	86.2	81.8	75.4	69.7	52.5					
23	68.1	71.0	68.8	68.1	70.1	66.8	62.2	52.5	43.4	34.8			
26	52.2	54.9	55.3	59.1	59.1	55.8	52.0	48.5	43.4	34.8	28.4		
30	41.9	44.1	46.5	47.8	48.1	47.4	44.5	44.1	39.7	34.8	28.4	22.5	
33			38.8	39.9	40.1	39.5	38.4	38.4	35.5	33.3	28.4	22.5	19.6
36			32.6	34.0	34.2	33.5	33.5	33.5	32.8	28.9	28.4	22.5	19.6
39			27.8	28.9	30.2	30.0	30.6	28.9	29.5	28.4	25.1	22.5	19.6
46				22.0	23.1	23.1	23.4	23.1	23.1	22.5	21.8	20.3	19.6
53				17.4	18.3	18.3	18.5	18.3	18.3	17.6	17.2	16.3	15.9
59					14.8	15.0	15.0	14.8	14.8	14.1	13.9	13.0	13.0
66					12.3	12.3	12.6	12.1	12.1	11.5	11.2	10.4	10.4
72						10.4	10.4	10.1	9.9	9.3	9.0	8.2	8.2
79							8.6	8.4	8.2	7.5	7.3	6.4	6.4
85							7.3	6.8	6.8	6.2	5.7	5.1	4.9
92								5.7	5.5	4.9	4.6	3.7	3.7
98								4.6	4.4	4.0	3.5	2.6	2.6
105									3.7	3.1	2.6	2.0	1.8
112									2.9	2.2	2.0	1.1	
118										1.5	1.3		
125										1.1			

* Over rear / * Sobre la parte trasera ** With additional lifting equipment / ** Con equipo adicional





0 lbs

lbs x 1,000 **SAE**

 ft	36.4 ft*	36.4 ft	48.5 ft	60.6 ft	72.6 ft	84.7 ft	96.8 ft	108.9 ft	120.9 ft	133.0 ft	145.1 ft	157.2 ft	168.0 ft	
7.5	220.5**													
8	198.4**													
10	175.0**	164.0	143.3	143.3										
12	158.1	148.4	143.3	143.3	110.2									
13	142.0	135.1	133.8	132.7	110.2	91.0								
15	125.0	121.5	120.2	110.2	102.5	91.0								
16	107.4	109.8	102.5	93.7	89.3	78.9	69.7							
20	77.8	81.6	75.2	71.2	72.8	67.5	61.9	52.5						
23	58.0	58.2	59.7	61.9	58.4	54.7	50.0	45.9	43.2	34.8				
26	44.3	44.3	47.2	48.5	48.1	44.5	42.3	40.6	35.5	34.4	28.4			
30	35.3	35.3	37.7	39.0	39.0	37.5	38.4	35.3	33.5	28.9	28.4	22.5		
33			31.1	32.4	33.5	33.7	33.1	31.3	30.0	28.0	24.3	22.5	19.6	
36			26.0	27.3	28.4	28.4	28.7	27.3	26.2	24.5	22.9	21.2	19.6	
39			22.3	23.4	24.5	24.5	24.7	24.0	22.9	21.4	20.3	18.5	18.1	
46				17.6	18.7	18.7	19.0	18.7	18.3	17.0	15.9	14.3	13.9	
53				13.9	14.8	15.0	15.0	14.8	14.8	13.4	12.6	11.2	11.0	
59					11.9	11.9	12.1	11.9	11.7	11.0	10.1	8.8	8.6	
66					9.7	9.7	9.7	9.5	9.3	8.6	8.2	7.1	6.8	
72						7.7	7.7	7.9	7.5	7.5	6.8	6.4	5.3	5.1
79							6.4	6.0	6.0	5.3	4.9	4.0	4.0	
85							5.3	4.9	4.6	4.0	3.7	2.9	2.9	
92								3.7	3.7	3.1	2.6	2.0	1.8	
98								3.1	2.9	2.2	1.8			
105									2.0	1.3				
112									1.3					

* Over rear / * Sobre la parte trasera ** With additional lifting equipment / ** Con equipo adicional

Lifting heights / Alturas de elevación









49,604 lbs

lbs x 1,000

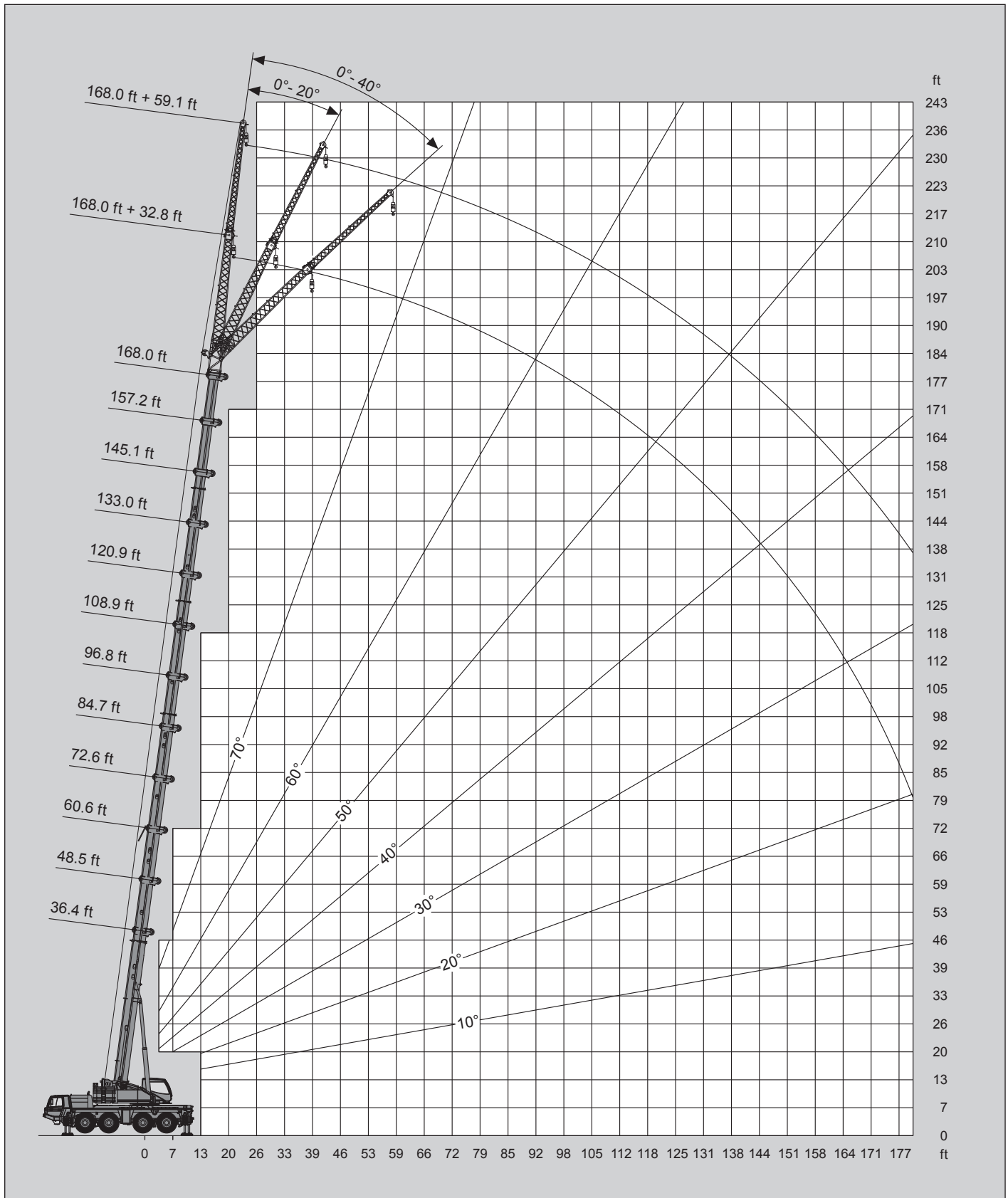
SAE

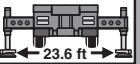



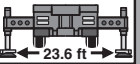

		 HYDRO*	 23.6 ft	 360°	49,604 lbs	lbs x 1,000	SAE
---	---	--	---	--	-------------------	-------------	------------

 ft	36.4 ft + 32.8 ft			108.9 ft + 32.8 ft			157.2 ft + 32.8 ft			168.0 ft + 32.8 ft		
	0°	20°	40°	0°	20°	40°	0°	20°	40°	0°	20°	40°
10	26.9											
12	26.9											
13	26.9											
15	26.9											
16	26.9	26.9										
20	26.9	25.4										
23	26.9	23.8		22.3								
26	26.9	22.5	16.3	22.3								
30	26.7	21.4	15.7	22.3								
33	24.9	19.8	14.8	22.3	19.8							
36	23.1	18.7	14.1	22.3	19.0		10.8					
39	21.2	17.6	13.7	22.3	18.3		10.8			9.7		
46	17.9	15.7	12.8	20.5	16.8	14.8	10.8			9.7		
53	15.4	14.3		18.7	15.7	13.9	10.8	10.8		9.7	9.7	
59				17.4	14.8	13.2	10.8	10.8	10.4	9.7	9.7	
66				16.3	13.9	12.6	10.8	10.6	9.9	9.7	9.7	9.3
72				15.2	13.2	12.1	10.8	10.1	9.5	9.7	9.5	8.8
79				14.3	12.6	11.5	10.4	9.7	9.0	9.7	9.0	8.6
85				13.7	12.1	11.2	9.9	9.3	8.6	9.0	8.6	8.2
92				11.7	11.5	10.8	9.5	8.8	8.4	8.6	8.4	7.9
98				10.1	10.8	10.6	8.8	8.6	7.9	8.2	7.9	7.7
105				8.8	9.3	9.7	8.4	8.2	7.7	7.7	7.5	7.3
112				7.5	7.9		7.9	7.9	7.5	7.5	7.3	7.1
118				6.4	6.8		6.8	7.3	7.3	6.6	6.8	6.8
125				5.5	5.7		5.7	6.4	6.8	5.7	6.2	6.6
131				4.9			4.9	5.5	5.7	4.9	5.3	5.7
138							4.2	4.6	4.9	4.0	4.6	4.9
144							3.5	4.0	4.2	3.3	3.7	4.0
151							2.9	3.3		2.6	3.1	3.3
158							2.4	2.6		2.2	2.4	
164							1.8	2.0		1.8	2.0	
171							1.3	1.5		1.1	1.5	

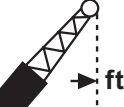
Lifting capacities / Capacidades de elevación

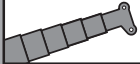

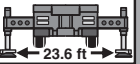

		 HYDRO*	 23.6 ft	 360°	49,604 lbs	lbs x 1,000	SAE
---	---	--	---	--	-------------------	-------------	------------

 ft	36.4 ft + 59.1 ft			108.9 ft + 59.1 ft			157.2 ft + 59.1 ft			168.0 ft + 59.1 ft		
	0°	20°	40°	0°	20°	40°	0°	20°	40°	0°	20°	40°
12	12.8											
13	12.8											
15	12.8											
16	12.8											
20	12.8											
23	12.8											
26	12.8			9.3								
30	12.8			9.3								
33	12.8	11.7		9.3								
36	12.8	11.0		9.3								
39	12.6	10.6		9.3			6.4					
46	11.2	9.7		9.3			6.4			6.0		
53	10.4	9.0	7.1	9.3	9.3		6.4			6.0		
59	9.3	8.2	6.6	9.3	9.0		6.4			6.0		
66	8.2	7.5	6.2	9.3	8.6	7.1	6.4	6.4		6.0		
72	7.3	6.8	5.7	9.3	8.4	6.8	6.4	6.4		6.0	6.0	
79	6.6	6.4	5.5	9.3	7.9	6.6	6.4	6.4		6.0	6.0	
85	6.0	6.2		9.3	7.7	6.4	6.4	6.4	6.4	6.0	6.0	6.0
92				9.0	7.5	6.2	6.4	6.4	6.2	6.0	6.0	5.7
98				8.6	7.3	6.0	6.4	6.4	6.0	6.0	6.0	5.7
105				8.4	7.1	5.7	6.4	6.0	5.7	6.0	5.7	5.5
112				7.9	6.8	5.7	6.4	6.0	5.5	6.0	5.5	5.3
118				7.7	6.6	5.5	6.2	5.7	5.3	6.0	5.3	5.1
125				6.6	6.4	5.5	6.0	5.5	5.3	5.7	5.1	4.9
131				5.7	6.4	5.5	5.5	5.3	5.1	5.3	5.1	4.9
138				5.1	5.7		4.9	5.1	4.9	4.6	4.9	4.6
144				4.4	4.9		4.2	4.9	4.9	4.0	4.6	4.6
151				3.7	4.2		3.5	4.2	4.6	3.3	4.0	4.4
158				3.3			2.9	3.5	4.0	2.6	3.3	4.0
164							2.4	2.9	3.3	2.2	2.9	3.3
171							2.0	2.4	2.6	1.8	2.2	2.6
177							1.5	2.0		1.3	1.8	2.0
184								1.5			1.3	

		 HYDRO*	 23.6 ft	 360°	35,935 lbs	lbs x 1,000	SAE
---	---	--	---	--	-------------------	-------------	------------

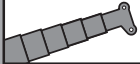
 ft	36.4 ft + 32.8 ft			108.9 ft + 32.8 ft			157.2 ft + 32.8 ft			168.0 ft + 32.8 ft		
	0°	20°	40°	0°	20°	40°	0°	20°	40°	0°	20°	40°
10	26.9											
12	26.9											
13	26.9											
15	26.9											
16	26.9	26.9										
20	26.9	25.4										
23	26.9	23.8		22.3								
26	26.9	22.5	16.3	22.3								
30	26.7	21.4	15.7	22.3								
33	24.9	19.8	14.8	22.3	19.8							
36	23.1	18.7	14.1	22.3	19.0		10.8					
39	21.2	17.6	13.7	22.3	18.3		10.8			9.7		
46	17.9	15.7	12.8	20.5	16.8	14.8	10.8			9.7		
53	15.4	14.3		18.7	15.7	13.9	10.8	10.8		9.7	9.7	
59				17.4	14.8	13.2	10.8	10.8	10.4	9.7	9.7	
66				16.3	13.9	12.6	10.8	10.6	9.9	9.7	9.7	9.3
72				14.8	13.2	12.1	10.8	10.1	9.5	9.7	9.5	8.8
79				12.6	12.6	11.5	10.4	9.7	9.0	9.7	9.0	8.6
85				10.6	11.5	11.2	9.9	9.3	8.6	9.0	8.6	8.2
92				8.8	9.7	10.1	9.3	8.8	8.4	8.6	8.4	7.9
98				7.3	8.2	8.6	7.7	8.6	7.9	7.7	7.9	7.7
105				6.2	6.8	7.1	6.6	7.3	7.7	6.4	7.3	7.3
112				5.1	5.5		5.5	6.2	6.6	5.3	6.0	6.6
118				4.2	4.6		4.4	5.1	5.5	4.4	5.1	5.5
125				3.3	3.7		3.5	4.2	4.6	3.5	4.2	4.4
131				2.6			2.9	3.3	3.7	2.6	3.3	3.7
138							2.2	2.6	2.9	2.0	2.6	2.9
144							1.5	2.0	2.2	1.5	2.0	2.2
151								1.3			1.3	1.5

Lifting capacities / Capacidades de elevación

		 HYDRO*	 23.6 ft	 360°	35,935 lbs	lbs x 1,000	SAE
---	---	--	---	--	-------------------	-------------	------------

 ft	36.4 ft + 59.1 ft			108.9 ft + 59.1 ft			157.2 ft + 59.1 ft			168.0 ft + 59.1 ft		
	0°	20°	40°	0°	20°	40°	0°	20°	40°	0°	20°	40°
12	12.8											
13	12.8											
15	12.8											
16	12.8											
20	12.8											
23	12.8											
26	12.8			9.3								
30	12.8			9.3								
33	12.8	11.7		9.3								
36	12.8	11.0		9.3								
39	12.6	10.6		9.3			6.4					
46	11.2	9.7		9.3			6.4			6.0		
53	10.4	9.0	7.1	9.3	9.3		6.4			6.0		
59	9.3	8.2	6.6	9.3	9.0		6.4			6.0		
66	8.2	7.5	6.2	9.3	8.6	7.1	6.4	6.4		6.0		
72	7.3	6.8	5.7	9.3	8.4	6.8	6.4	6.4		6.0	6.0	
79	6.6	6.4	5.5	9.3	7.9	6.6	6.4	6.4		6.0	6.0	
85	6.0	6.2		9.3	7.7	6.4	6.4	6.4	6.4	6.0	6.0	6.0
92				9.0	7.5	6.2	6.4	6.4	6.2	6.0	6.0	5.7
98				8.6	7.3	6.0	6.4	6.4	6.0	6.0	6.0	5.7
105				7.5	7.1	5.7	6.4	6.0	5.7	6.0	5.7	5.5
112				6.4	6.8	5.7	6.2	6.0	5.5	6.0	5.5	5.3
118				5.3	6.4	5.5	5.1	5.7	5.3	4.9	5.3	5.1
125				4.6	5.3	5.5	4.2	5.3	5.3	4.0	5.1	4.9
131				3.7	4.6	4.9	3.5	4.4	5.1	3.3	4.4	4.9
138				3.1	3.7		2.9	3.7	4.4	2.6	3.5	4.4
144				2.4	3.1		2.2	3.1	3.5	2.0	2.9	3.5
151				2.0	2.4		1.8	2.4	2.9	1.5	2.2	2.9
158				1.5			1.1	1.8	2.2		1.8	2.2
164								1.3	1.8		1.1	1.5
171									1.1			





		 HYDRO*	 23.6 ft	 360°	22,487 lbs	lbs x 1,000	SAE
---	---	--	---	--	-------------------	-------------	------------



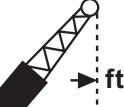

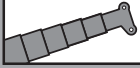
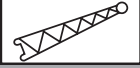
 ft	36.4 ft + 32.8 ft			108.9 ft + 32.8 ft			157.2 ft + 32.8 ft			168.0 ft + 32.8 ft		
	0°	20°	40°	0°	20°	40°	0°	20°	40°	0°	20°	40°
10	26.9											
12	26.9											
13	26.9											
15	26.9											
16	26.9	26.9										
20	26.9	25.4										
23	26.9	23.8		22.3								
26	26.9	22.5	16.3	22.3								
30	26.7	21.4	15.7	22.3								
33	24.9	19.8	14.8	22.3	19.8							
36	23.1	18.7	14.1	22.3	19.0		10.8					
39	21.2	17.6	13.7	22.3	18.3		10.8			9.7		
46	17.9	15.7	12.8	20.5	16.8	14.8	10.8			9.7		
53	15.4	14.3		18.7	15.7	13.9	10.8	10.8		9.7	9.7	
59				16.8	14.8	13.2	10.8	10.8	10.4	9.7	9.7	
66				13.4	13.9	12.6	10.8	10.6	9.9	9.7	9.7	9.3
72				10.8	12.1	12.1	10.8	10.1	9.5	9.7	9.5	8.8
79				8.8	9.9	10.6	9.3	9.7	9.0	9.0	9.0	8.6
85				7.1	7.9	8.6	7.5	8.6	8.6	7.3	8.4	8.2
92				5.7	6.4	7.1	6.0	7.1	7.7	6.0	6.8	7.7
98				4.4	5.1	5.5	4.9	5.7	6.4	4.6	5.5	6.2
105				3.5	4.0	4.4	3.7	4.6	5.1	3.7	4.4	5.1
112				2.4	3.1		2.9	3.5	4.0	2.6	3.5	4.0
118				1.8	2.2		2.0	2.6	3.1	2.0	2.6	3.1
125				1.1	1.3		1.3	2.0	2.4	1.3	1.8	2.2
131								1.3	1.5		1.1	1.5

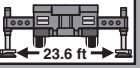
Lifting capacities / Capacidades de elevación

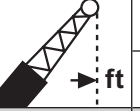

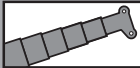
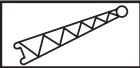

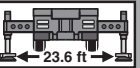
		 HYDRO*	 23.6 ft	 360°	22,487 lbs	lbs x 1,000	SAE
---	---	--	---	--	-------------------	-------------	------------

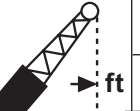

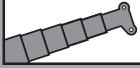
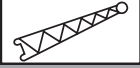

 ft	36.4 ft + 59.1 ft			108.9 ft + 59.1 ft			157.2 ft + 59.1 ft			168.0 ft + 59.1 ft		
	0°	20°	40°	0°	20°	40°	0°	20°	40°	0°	20°	40°
12	12.8											
13	12.8											
15	12.8											
16	12.8											
20	12.8											
23	12.8											
26	12.8			9.3								
30	12.8			9.3								
33	12.8	11.7		9.3								
36	12.8	11.0		9.3								
39	12.6	10.6		9.3			6.4					
46	11.2	9.7		9.3			6.4			6.0		
53	10.4	9.0	7.1	9.3	9.3		6.4			6.0		
59	9.3	8.2	6.6	9.3	9.0		6.4			6.0		
66	8.2	7.5	6.2	9.3	8.6	7.1	6.4	6.4		6.0		
72	7.3	6.8	5.7	9.3	8.4	6.8	6.4	6.4		6.0	6.0	
79	6.6	6.4	5.5	9.3	7.9	6.6	6.4	6.4		6.0	6.0	
85	6.0	6.2		8.4	7.7	6.4	6.4	6.4	6.4	6.0	6.0	6.0
92				7.1	7.5	6.2	6.4	6.4	6.2	6.0	6.0	5.7
98				5.7	7.3	6.0	5.5	6.4	6.0	5.3	6.0	5.7
105				4.6	6.0	5.7	4.4	6.0	5.7	4.2	5.7	5.5
112				3.7	4.9	5.7	3.5	4.9	5.5	3.3	4.6	5.3
118				3.1	4.0	4.6	2.6	4.0	4.9	2.4	3.7	4.9
125				2.2	3.1	3.7	2.0	3.1	4.0	1.8	2.9	3.7
131				1.8	2.4	2.9	1.3	2.4	3.1	1.1	2.2	3.1
138				1.1	1.8			1.8	2.4		1.5	2.2
144					1.1			1.1	1.8			1.5
151									1.1			

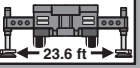

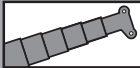
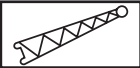

     16,755 lbs lbs x 1,000 SAE												
 ft	36.4 ft + 32.8 ft			108.9 ft + 32.8 ft			157.2 ft + 32.8 ft			168.0 ft + 32.8 ft		
	0°	20°	40°	0°	20°	40°	0°	20°	40°	0°	20°	40°
10	26.9											
12	26.9											
13	26.9											
15	26.9											
16	26.9	26.9										
20	26.9	25.4										
23	26.9	23.8		22.3								
26	26.9	22.5	16.3	22.3								
30	26.7	21.4	15.7	22.3								
33	24.9	19.8	14.8	22.3	19.8							
36	23.1	18.7	14.1	22.3	19.0		10.8					
39	21.2	17.6	13.7	22.3	18.3		10.8			9.7		
46	17.9	15.7	12.8	20.5	16.8	14.8	10.8			9.7		
53	15.4	14.3		18.3	15.7	13.9	10.8	10.8		9.7	9.7	
59				14.3	14.8	13.2	10.8	10.8	10.4	9.7	9.7	
66				11.5	12.8	12.6	10.8	10.6	9.9	9.7	9.7	9.3
72				9.0	10.4	11.2	9.5	10.1	9.5	9.3	9.5	8.8
79				7.1	8.2	9.0	7.5	8.8	9.0	7.5	8.6	8.6
85				5.5	6.6	7.3	6.0	7.1	7.9	6.0	7.1	7.9
92				4.2	5.1	5.7	4.6	5.7	6.4	4.6	5.5	6.4
98				3.1	4.0	4.4	3.5	4.4	5.1	3.5	4.4	5.1
105				2.2	2.9	3.1	2.6	3.3	4.0	2.4	3.3	4.0
112				1.5	2.0		1.8	2.4	2.9	1.5	2.4	2.9
118					1.1			1.8	2.2		1.5	2.0
125									1.3			1.3

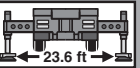

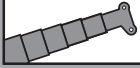
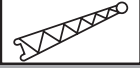

     16,755 lbs lbs x 1,000 SAE												
 ft	36.4 ft + 59.1 ft			108.9 ft + 59.1 ft			157.2 ft + 59.1 ft			168.0 ft + 59.1 ft		
	0°	20°	40°	0°	20°	40°	0°	20°	40°	0°	20°	40°
12	12.8											
13	12.8											
15	12.8											
16	12.8											
20	12.8											
23	12.8											
26	12.8			9.3								
30	12.8			9.3								
33	12.8	11.7		9.3								
36	12.8	11.0		9.3								
39	12.6	10.6		9.3			6.4					
46	11.2	9.7		9.3			6.4			6.0		
53	10.4	9.0	7.1	9.3	9.3		6.4			6.0		
59	9.3	8.2	6.6	9.3	9.0		6.4			6.0		
66	8.2	7.5	6.2	9.3	8.6	7.1	6.4	6.4		6.0		
72	7.3	6.8	5.7	9.3	8.4	6.8	6.4	6.4		6.0	6.0	
79	6.6	6.4	5.5	8.6	7.9	6.6	6.4	6.4		6.0	6.0	
85	6.0	6.2		7.1	7.7	6.4	6.4	6.4	6.4	6.0	6.0	6.0
92				5.7	7.3	6.2	5.3	6.4	6.2	5.1	6.0	5.7
98				4.6	6.0	6.0	4.2	5.7	6.0	4.0	5.7	5.7
105				3.5	4.9	5.7	3.3	4.6	5.7	3.1	4.6	5.5
112				2.6	3.7	4.6	2.4	3.7	4.9	2.2	3.5	4.6
118				2.0	2.9	3.7	1.8	2.9	3.7	1.5	2.6	3.7
125				1.3	2.2	2.6		2.2	2.9		2.0	2.9
131					1.5	2.0		1.5	2.2			2.2
138									1.5			1.5

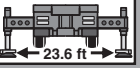
Lifting capacities / Capacidades de elevación

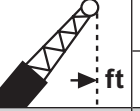

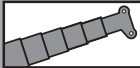
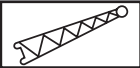

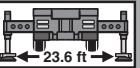
     13,228 lbs lbs x 1,000 SAE												
 ft	36.4 ft + 32.8 ft			108.9 ft + 32.8 ft			157.2 ft + 32.8 ft			168.0 ft + 32.8 ft		
	0°	20°	40°	0°	20°	40°	0°	20°	40°	0°	20°	40°
10	26.9											
12	26.9											
13	26.9											
15	26.9											
16	26.9	26.9										
20	26.9	25.4										
23	26.9	23.8		22.3								
26	26.9	22.5	16.3	22.3								
30	26.7	21.4	15.7	22.3								
33	24.9	19.8	14.8	22.3	19.8							
36	23.1	18.7	14.1	22.3	19.0		10.8					
39	21.2	17.6	13.7	22.3	18.3		10.8			9.7		
46	17.9	15.7	12.8	20.5	16.8	14.8	10.8			9.7		
53	15.4	14.3		16.8	15.7	13.9	10.8	10.8		9.7	9.7	
59				13.0	14.8	13.2	10.8	10.8	10.4	9.7	9.7	
66				10.1	11.7	12.6	10.4	10.6	9.9	9.7	9.7	9.3
72				7.9	9.3	10.1	8.4	9.7	9.5	8.2	9.5	8.8
79				6.2	7.3	7.9	6.6	7.7	8.8	6.4	7.7	8.6
85				4.6	5.5	6.4	5.1	6.2	7.1	4.9	6.2	7.1
92				3.5	4.2	4.9	4.0	4.9	5.5	3.7	4.6	5.5
98				2.4	3.1	3.5	2.9	3.7	4.4	2.6	3.5	4.2
105				1.5	2.2	2.4	2.0	2.6	3.3	1.8	2.6	3.1
112					1.3		1.1	1.8	2.4		1.8	2.2
118									1.5			1.3

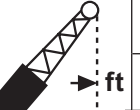

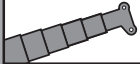

     13,228 lbs lbs x 1,000 SAE												
 ft	36.4 ft + 59.1 ft			108.9 ft + 59.1 ft			157.2 ft + 59.1 ft			168.0 ft + 59.1 ft		
	0°	20°	40°	0°	20°	40°	0°	20°	40°	0°	20°	40°
12	12.8											
13	12.8											
15	12.8											
16	12.8											
20	12.8											
23	12.8											
26	12.8			9.3								
30	12.8			9.3								
33	12.8	11.7		9.3								
36	12.8	11.0		9.3								
39	12.6	10.6		9.3			6.4					
46	11.2	9.7		9.3			6.4			6.0		
53	10.4	9.0	7.1	9.3	9.3		6.4			6.0		
59	9.3	8.2	6.6	9.3	9.0		6.4			6.0		
66	8.2	7.5	6.2	9.3	8.6	7.1	6.4	6.4		6.0		
72	7.3	6.8	5.7	9.3	8.4	6.8	6.4	6.4		6.0	6.0	
79	6.6	6.4	5.5	7.5	7.9	6.6	6.4	6.4		6.0	6.0	
85	6.0	6.2		6.2	7.7	6.4	5.7	6.4	6.4	5.5	6.0	6.0
92				4.9	6.4	6.2	4.6	6.4	6.2	4.4	6.0	5.7
98				3.7	5.1	6.0	3.5	5.1	6.0	3.3	4.9	5.7
105				2.9	4.0	5.1	2.6	4.0	5.1	2.4	3.7	5.1
112				2.0	3.1	4.0	1.8	3.1	4.2		2.9	4.0
118				1.3	2.4	3.1		2.2	3.3		2.2	3.1
125					1.5	2.2		1.5	2.4			2.2
131						1.3			1.8			1.5

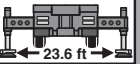
     11,243 lbs lbs x 1,000 SAE												
 ft	36.4 ft + 32.8 ft			108.9 ft + 32.8 ft			157.2 ft + 32.8 ft			168.0 ft + 32.8 ft		
	0°	20°	40°	0°	20°	40°	0°	20°	40°	0°	20°	40°
10	26.9											
12	26.9											
13	26.9											
15	26.9											
16	26.9	26.9										
20	26.9	25.4										
23	26.9	23.8		22.3								
26	26.9	22.5	16.3	22.3								
30	26.7	21.4	15.7	22.3								
33	24.9	19.8	14.8	22.3	19.8							
36	23.1	18.7	14.1	22.3	19.0		10.8					
39	21.2	17.6	13.7	22.3	18.3		10.8			9.7		
46	17.9	15.7	12.8	20.1	16.8	14.8	10.8			9.7		
53	15.4	14.3		15.9	15.7	13.9	10.8	10.8		9.7	9.7	
59				12.1	13.9	13.2	10.8	10.8	10.4	9.7	9.7	
66				9.5	10.8	12.1	9.7	10.6	9.9	9.3	9.7	9.3
72				7.3	8.6	9.5	7.7	9.3	9.5	7.5	8.8	8.8
79				5.5	6.6	7.5	6.0	7.3	8.2	6.0	7.1	8.2
85				4.2	5.1	5.7	4.6	5.7	6.6	4.4	5.5	6.4
92				2.9	3.7	4.4	3.3	4.4	5.1	3.3	4.2	5.1
98				2.0	2.6	3.1	2.4	3.3	4.0	2.2	3.1	3.7
105				1.1	1.8	2.0	1.5	2.2	2.9		2.2	2.9
112								1.5	2.0			1.8

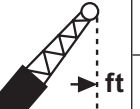
     11,243 lbs lbs x 1,000 SAE												
 ft	36.4 ft + 59.1 ft			108.9 ft + 59.1 ft			157.2 ft + 59.1 ft			168.0 ft + 59.1 ft		
	0°	20°	40°	0°	20°	40°	0°	20°	40°	0°	20°	40°
12	12.8											
13	12.8											
15	12.8											
16	12.8											
20	12.8											
23	12.8											
26	12.8			9.3								
30	12.8			9.3								
33	12.8	11.7		9.3								
36	12.8	11.0		9.3								
39	12.6	10.6		9.3			6.4					
46	11.2	9.7		9.3			6.4			6.0		
53	10.4	9.0	7.1	9.3	9.3		6.4			6.0		
59	9.3	8.2	6.6	9.3	9.0		6.4			6.0		
66	8.2	7.5	6.2	9.3	8.6	7.1	6.4	6.4		6.0		
72	7.3	6.8	5.7	8.8	8.4	6.8	6.4	6.4		6.0	6.0	
79	6.6	6.4	5.5	7.1	7.9	6.6	6.4	6.4		6.0	6.0	
85	6.0	6.2		5.5	7.3	6.4	5.3	6.4	6.4	5.1	6.0	6.0
92				4.4	6.0	6.2	4.2	5.7	6.2	4.0	5.7	5.7
98				3.3	4.6	6.0	3.1	4.6	6.0	2.9	4.4	5.7
105				2.4	3.7	4.6	2.2	3.5	4.9	2.0	3.5	4.6
112				1.8	2.6	3.5		2.6	3.7		2.6	3.7
118					2.0	2.6		2.0	2.9		1.8	2.6
125					1.3	1.8			2.0			2.0
131									1.3			

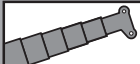
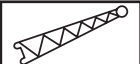
Lifting capacities / Capacidades de elevación

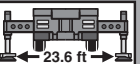
     0 lbs lbs x 1,000 SAE												
 ft	36.4 ft + 32.8 ft			108.9 ft + 32.8 ft			157.2 ft + 32.8 ft			168.0 ft + 32.8 ft		
	0°	20°	40°	0°	20°	40°	0°	20°	40°	0°	20°	40°
10	26.9											
12	26.9											
13	26.9											
15	26.9											
16	26.9	26.9										
20	26.9	25.4										
23	26.9	23.8		22.3								
26	26.9	22.5	16.3	22.3								
30	26.7	21.4	15.7	22.3								
33	24.9	19.8	14.8	22.3	19.8							
36	23.1	18.7	14.1	21.2	19.0		10.8					
39	21.2	17.6	13.7	18.5	18.3		10.8			9.7		
46	17.9	15.7	12.8	14.1	16.3	14.8	10.8			9.7		
53	15.4	14.3		10.8	12.8	13.9	9.9	10.8		9.5	9.7	
59				8.4	9.9	11.5	7.7	9.3	10.4	7.3	8.8	
66				6.4	7.7	9.0	6.0	7.3	8.4	5.5	6.8	8.2
72				4.9	6.0	7.1	4.4	5.5	6.6	4.0	5.3	6.4
79				3.3	4.4	5.3	3.1	4.2	5.1	2.9	4.0	4.9
85				2.2	3.1	3.7	2.0	3.1	4.0		2.9	3.7
92				1.1	2.0	2.4		2.0	2.9			2.6
98						1.5			1.8			

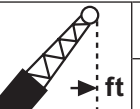
     0 lbs lbs x 1,000 SAE												
 ft	36.4 ft + 59.1 ft			108.9 ft + 59.1 ft			157.2 ft + 59.1 ft			168.0 ft + 59.1 ft		
	0°	20°	40°	0°	20°	40°	0°	20°	40°	0°	20°	40°
12	12.8											
13	12.8											
15	12.8											
16	12.8											
20	12.8											
23	12.8											
26	12.8			9.3								
30	12.8			9.3								
33	12.8	11.7		9.3								
36	12.8	11.0		9.3								
39	12.6	10.6		9.3			6.4					
46	11.2	9.7		9.3			6.4			6.0		
53	10.4	9.0	7.1	9.3	9.3		6.4			6.0		
59	9.3	8.2	6.6	9.3	9.0		6.4			6.0		
66	8.2	7.5	6.2	7.5	8.6	7.1	6.2	6.4		5.7		
72	7.3	6.8	5.7	5.7	7.9	6.8	4.9	6.4		4.4	6.0	
79	6.6	6.4	5.5	4.4	6.4	6.6	3.5	5.5		3.3	5.3	
85	6.0	6.2		3.3	5.1	6.4	2.4	4.4	6.0		4.0	5.7
92				2.4	4.0	5.3		3.3	4.9		3.1	4.4
98				1.5	2.9	4.2		2.4	3.7		2.2	3.5
105					2.2	3.1			2.6			2.4
112					1.3	2.2			2.0			
118						1.3						

Lifting heights / Alturas de elevación

Lifting capacities / Capacidades de elevación



49,604 lbs lbs x 1,000 **SAE**



49,604 lbs lbs x 1,000 **SAE**

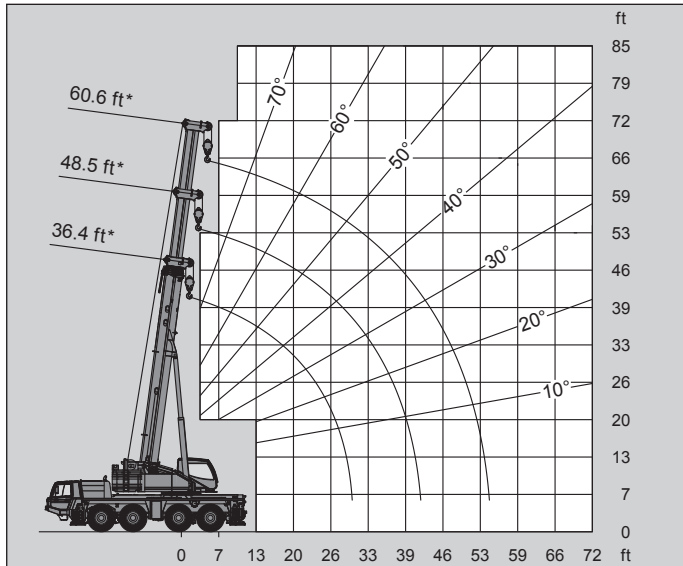

ft	36.4 ft	48.5 ft	60.6 ft
10	38.4	39.5	40.1
12	34.8	36.2	36.6
13	31.7	33.1	33.5
15	29.1	30.4	31.1
16	26.9	28.0	28.7
20	23.1	24.3	24.7
23	20.1	21.2	21.6
26	17.6	18.7	19.2
30	15.7	16.5	17.2
33		14.8	15.4
36		13.4	13.9
39		12.1	12.8
46			10.6
53			8.6

* Superstructure locked / * Bloqueo de superestructura



35,935 lbs lbs x 1,000 **SAE**



22,487 lbs lbs x 1,000 **SAE**

ft	36.4 ft	48.5 ft	60.6 ft
10	39.2	40.3	41.0
12	35.7	36.8	37.5
13	32.6	33.7	34.4
15	29.8	31.1	31.7
16	27.6	28.7	29.3
20	23.6	24.7	25.4
23	20.5	21.6	22.3
26	18.1	19.0	19.6
30	15.4	16.8	17.6
33		14.8	15.4
36		12.6	13.4
39		10.6	11.5
46			8.6
53			6.6

ft	36.4 ft	48.5 ft	60.6 ft
10	40.1	41.2	41.7
12	36.6	37.7	38.1
13	33.3	34.6	35.1
15	30.6	31.7	32.4
16	28.2	29.3	30.0
20	23.4	25.4	26.0
23	18.1	20.1	21.2
26	14.3	16.3	17.2
30	11.5	13.2	14.1
33		10.8	11.9
36		9.0	9.9
39		7.7	8.6
46			6.4
53			4.4



13,228 lbs lbs x 1,000 **SAE**



11,243 lbs lbs x 1,000 **SAE**

ft	36.4 ft	48.5 ft	60.6 ft
10	40.8	41.9	42.3
12	37.0	38.1	38.8
13	33.7	35.1	35.5
15	30.4	32.2	32.2
16	25.6	27.8	28.9
20	19.0	20.9	22.0
23	14.3	16.3	17.2
26	11.2	12.8	13.9
30	8.8	10.4	11.5
33		8.6	9.5
36		7.1	7.9
39		5.7	6.6
46			4.6
53			3.1

ft	36.4 ft	48.5 ft	60.6 ft
10	40.8	41.9	42.5
12	37.3	38.4	38.8
13	34.0	35.1	34.8
15	28.9	31.3	30.9
16	24.5	26.7	27.6
20	17.9	20.1	20.9
23	13.4	15.4	16.5
26	10.4	12.1	13.2
30	7.9	9.7	10.6
33		7.7	8.8
36		6.4	7.3
39		5.1	6.2
46			4.2
53			2.6

Axle weight distribution chart / Distribución de pesos por ejes

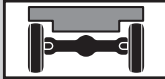
	Axle Eje	1	2	3	4	Total weight Peso total
	Tires 525/80 R 25 (20.50 R 25) [lbs]		27,804	27,582	19,636	19,529

Boom to front	Total [lbs]	Axle 1 [lbs]	Axle 2 [lbs]	Axle 3 [lbs]	Axle 4 [lbs]
Base machine with equipment for USA, 16.00 R 25 tires, 8 x 6 drive, additional cabine heater, air condition in carrier and upperstructure, reversing camera, no counterweight, no fuel, no driver	84,502	24,916	25,159	17,315	17,111
* Fuel in carrier	758	-109	-123	492	498
* Fuel in superstructure	436	-17	-24	237	241
* Driver in carrier	198	181	183	-85	-81
* 6.6 ton [6.0 t]** headache ball between axle 2 and 3	331	85	82	80	84
44.1ton [40.0 t]** (3 sheaves) hook block in front (at bumper)	1,213	1,279	1,296	-693	-669
32.8 ft / 59.1 ft Mechanical offset boom extension	3,192	1,942	1,948	-373	-324
* 32.8 ft / 59.1 ft Hydraulic offset boom extension	3,920	2,612	2,626	-690	-628
* Auxiliary winch with cable (Counterweight 1 removed)	2,356	-739	-793	1,937	1,950
* Auxiliary boom point sheave (single top)	127	150	152	-89	-86
* 2 nd oil cooler	98	-3	-4	52	53
* Drive 8 x 8	651	525	124	1	1
* 20.50 R 25 tires in lieu of 16.00 R 25 tires	1,023	256	256	256	256
Eddy-current brake	516	31	31	-7	461
* Tool box at rear	153	-53	-56	131	131

* Basic configuration, marked items are included

Counterweight at the upper:					
Counterweight 1: 2,205 lbs [1.0 t]**	2,313	-684	-736	1,860	1,874
Counterweight 2+3+4: 5,511 lbs [2.5 t]**	5,526	-1,428	-1,546	4,232	4,268
Counterweight 5 (No. 1): 3,527 lbs [1.6 t]**	3,445	-890	-964	2,639	2,661
Counterweight 5 (No. 2): 3,527 lbs [1.6 t]**	3,445	-890	-964	2,639	2,661
Counterweight 8: 1,985 lbs [0.9 t]**	1,985	-513	-556	1,520	1,533
Counterweight 7: (No. 1) 6,393 lbs [2.9 t]**	6,390	-1,652	-1,789	4,895	4,936
Counterweight 7: (No. 2) 6,393 lbs [2.9 t]**	6,390	-1,652	-1,789	4,895	4,936
Counterweight 7: (No. 3) 6,393 lbs [2.9 t]**	6,390	-1,652	-1,789	4,895	4,936
Counterweight 6: 13,670 lbs [6.2 t]**	13,662	-3,532	-3,824	10,465	10,553

Counterweight on the carrier:					
Counterweight 5 (No. 1): 3,527 lbs [1.6 t]**	3,445	1,534	1,526	169	216
Counterweight 5 (No. 2): 3,527 lbs [1.6 t]**	3,445	1,534	1,526	169	216
Counterweight 8: 1,985 lbs [0.9 t]**	1,985	884	879	97	124
Counterweight 7: (No. 1) 6,393 lbs [2.9 t]**	6,390	2,846	2,830	313	401
Counterweight 7: (No. 2) 6,393 lbs [2.9 t]**	6,390	2,846	2,830	313	401
Counterweight 7: (No. 3) 6,393 lbs [2.9 t]**	6,390	2,846	2,830	313	401
Counterweight 6: 13,670 lbs [6.2 t]**	13,662	6,085	6,051	670	856

** Metric

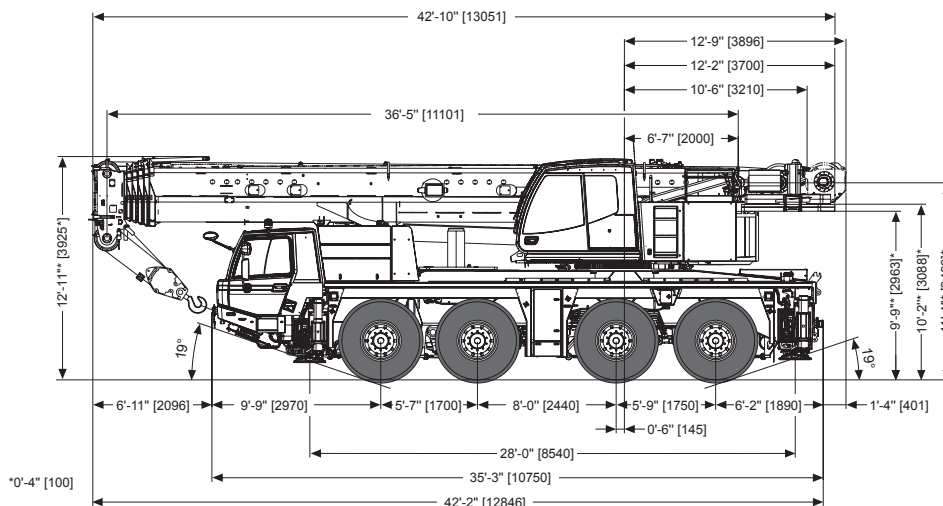

Axle weight distribution chart / Distribución de pesos por ejes

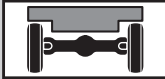
	Axle Eje	1	2	3	4	Dolly	Total weight Peso total
	Tires 525/80 R 25 (20.50 R 25) [lbs]		22,186	22,067	16,533	16,209	17,555

Boom in dolly, 29.2 ft behind boom pivot point	Total [lbs]	Axle 1 [lbs]	Axle 2 [lbs]	Axle 3 [lbs]	Axle 4 [lbs]	Dolly [lbs]
Base machine with equipment for USA, 16.00 R 25 tires, 8 x 6 drive, additional cabine heater, air condition in carrier and upperstructure, reversing camera, no counterweight, no fuel, no driver	84,502	19,704	20,015	15,394	15,002	14,391
* Fuel in carrier	758	-109	-123	492	498	0
* Fuel in superstructure	436	99	95	119	124	0
* Driver in carrier	198	181	183	-85	-81	0
* 6.6 ton [6.0 t]** headache ball between axle 2 and 3	331	85	82	80	84	0
44.1ton [40.0 t]** (3 sheaves) hook block in front (at bumper)	1,212	-100	-98	-50	-53	1,513
32.8 ft / 59.1 ft Mechanical offset boom extension	3,193	305	300	152	164	2,272
* 32.8 ft / 59.1 ft Hydraulic offset boom extension	3,920	303	298	151	163	3,005
* Auxiliary winch with cable (Counterweight 1 removed)	2,356	1,186	1,184	-24	9	0
* Auxiliary boom point sheave (single top)	126	-11	-11	-5	-6	159
* 2 nd oil cooler	98	21	20	28	29	0
* Drive 8 x 8	651	525	124	1	1	0
* 20.50 R 25 tires in lieu of 16.00 R 25 tires	1,023	256	256	256	256	0
Eddy-current brake	516	31	31	-7	461	0
* Tool box at rear	153	-53	-56	131	131	0

* Basic configuration, marked items are included

Counterweight at the upper:						
Counterweight 1: 2,205 lbs [1.0 t]**	2,313	1,116	1,113	26	58	0
Counterweight 2+3+4: 5,511 lbs [2.5 t]**	5,526	2,461	2,447	272	347	0
Counterweight 5 (No. 1): 3,527 lbs [1.6 t]**	3,445	1,534	1,526	169	216	0
Counterweight 5 (No. 2): 3,527 lbs [1.6 t]**	3,445	1,534	1,526	169	216	0
Counterweight 8: 1,985 lbs [0.9 t]**	1,985	884	879	97	124	0
Counterweight 7: (No. 1) 6,393 lbs [2.9 t]**	6,390	2,846	2,830	313	401	0
Counterweight 7: (No. 2) 6,393 lbs [2.9 t]**	6,390	2,846	2,830	313	401	0
Counterweight 7: (No. 3) 6,393 lbs [2.9 t]**	6,390	2,846	2,830	313	401	0
Counterweight 6: 13,670 lbs [6.2 t]**	13,662	6,085	6,051	670	856	0

Counterweight on the carrier:						
Counterweight 5 (No. 1): 3,527 lbs [1.6 t]**	3,445	1,534	1,526	169	216	0
Counterweight 5 (No. 2): 3,527 lbs [1.6 t]**	3,445	1,534	1,526	169	216	0
Counterweight 8: 1,985 lbs [0.9 t]**	1,985	884	879	97	124	0
Counterweight 7: (No. 1) 6,393 lbs [2.9 t]**	6,390	2,846	2,830	313	401	0
Counterweight 7: (No. 2) 6,393 lbs [2.9 t]**	6,390	2,846	2,830	313	401	0
Counterweight 7: (No. 3) 6,393 lbs [2.9 t]**	6,390	2,846	2,830	313	401	0
Counterweight 6: 13,670 lbs [6.2 t]**	13,662	6,085	6,051	670	856	0

** Metric

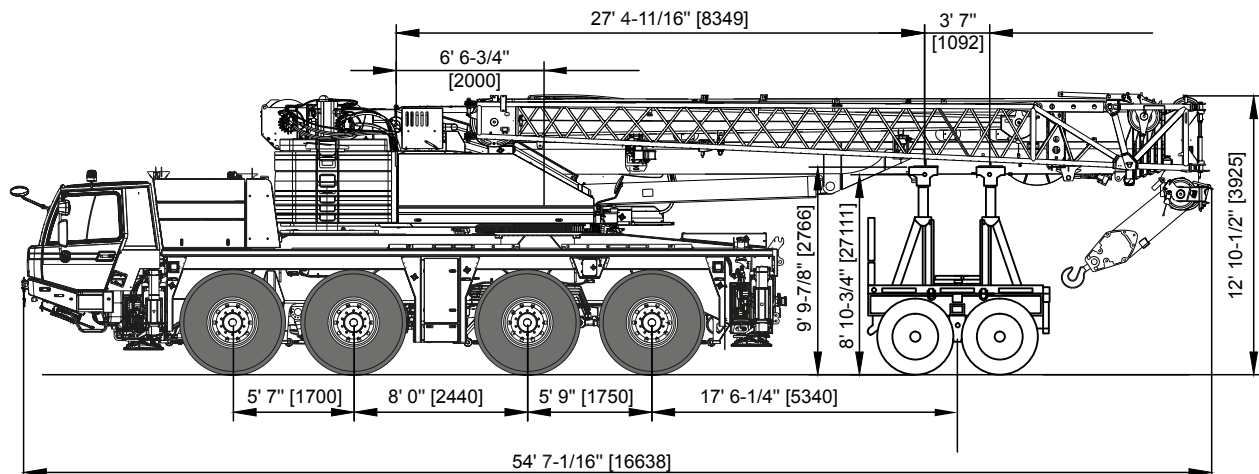

Counterweight versions / Variaciones de contrapeso

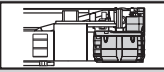
	Counterweight Contrapeso	1x	1x	1x	1x	2x	1x	3x	1x
		①	②	③	④	⑤	⑥	⑦	⑧
	[lbs]	2,205	1,543	1,543	2,425	3,527	13,670	6,393	1,985

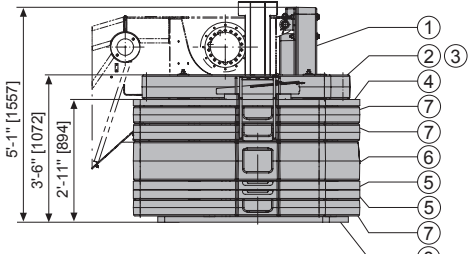
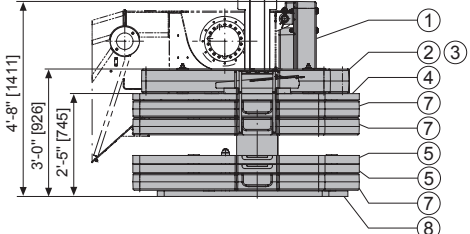
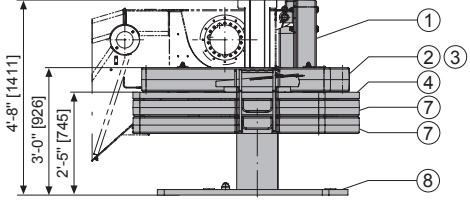
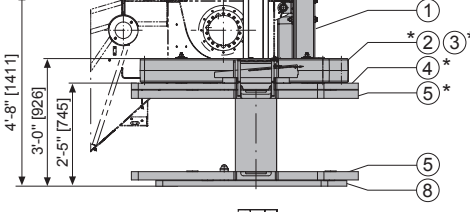
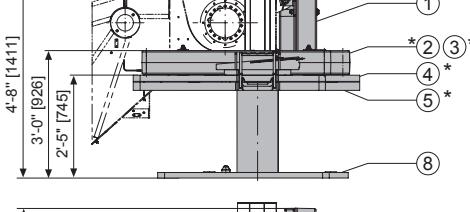
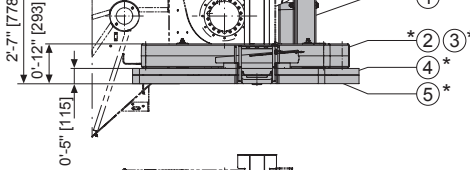
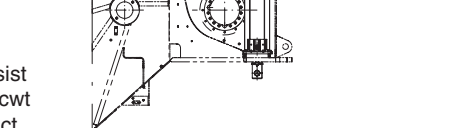
49,604 lbs	
35,935 lbs	
22,487 lbs	
16,755 lbs	
13,228 lbs	
11,243 lbs	
0 lbs	

* Denotes cwt's requiring assist vehicle unless appropriate cwt configuration is used to erect

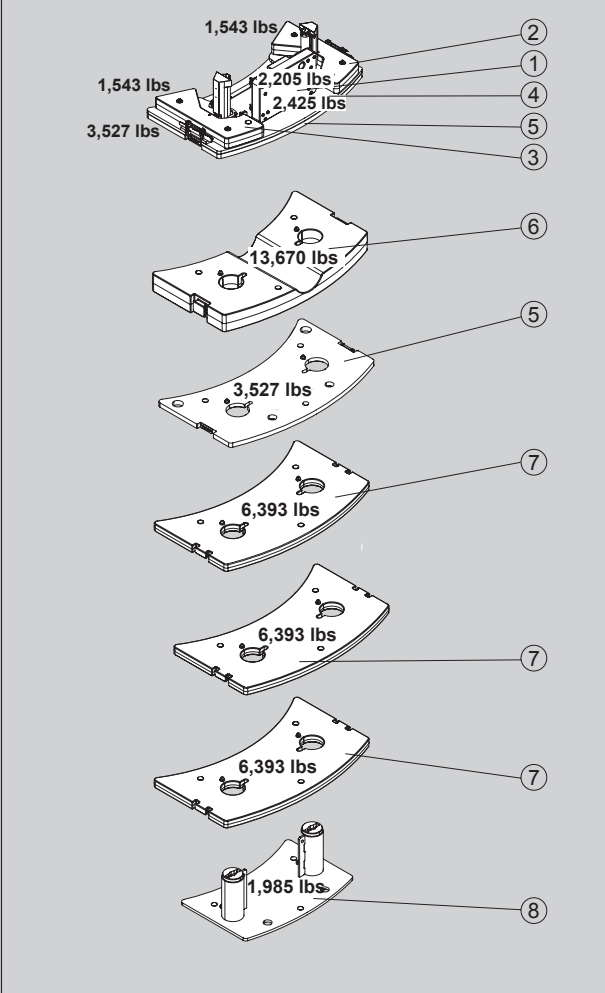
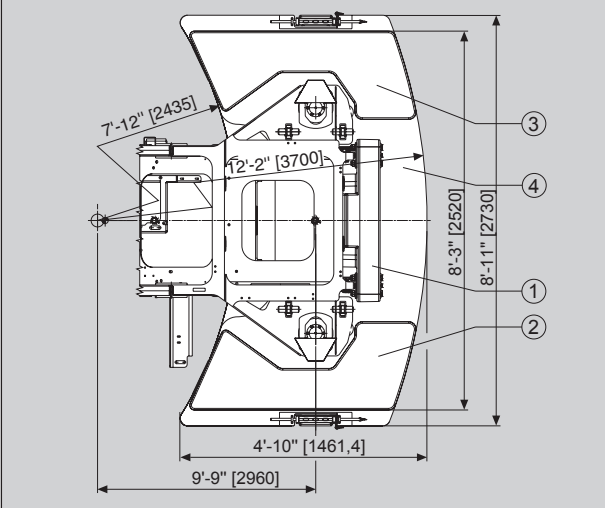

Frame Torsion-resistant, welded construction made from high strength, fine grained steel. Central lubricating system.

Outriggers 4 point, double telescopic hydraulic outriggers incl. automatic length detection and controls on both sides of carrier and in superstructure cab. Outrigger base 23'-7" (7.2 m) {16'-5" (5.0 m) mid extension} x 28'-0" (8.54 m).

Carrier engine Mercedes-Benz 6 cylinder model OM 470 LA (Euromot IV b/EPA Tier 4f), water-cooled diesel engine. Rated at 435 HP (320 kW) at 1,700 rpm. Torque 1549 ft-lbs (2,100 Nm / 214 kpm) at 1,300 rpm. Engine rating according to ECE R 120. Fuel tank 106 gal (400 l). DEF Tank 11 gal (40 l).

Transmission ZF-AS-Tronic 12 AS 2513 mechanical transmission with integrated intarder, electro-pneumatically operated dry-type clutch and automatic gear shifting with 12 forward gears and 2 reverse gears.

Transfer Case Two stage.

Drive 8 x 6 (8 x 8 optional)

Axles

1st axle: steered, not driven.

2nd axle: steered, driven.

3rd axle: steered, driven, with transverse and longitudinal differential lock.

4th axle: steered, driven, with transverse differential lock.

Suspension Hydro-pneumatic with levelling adjustment.

Brake system Service disc brakes: dual circuit compressed air system. Parking brake: spring loaded type acting on 2nd, 3rd and 4th axle. Auxiliary brakes: Intarder and engine brake.

Tires (8) 445/95 R 25 (16.00 R 25), width 9' (2.75 m).
(8) 525/80 R 25 (20.50 R 25), width 9'-9" (2.97 m).

Steering system ZF-Servocom, dual circuit hydraulic steering with emergency steering pump, mechanical hydraulically-assisted steering of front two axles and automatic steering of the 4th axle up to a travel speed of 15.5 mph (25 km / h). Steering of all axles possible. All axles steered hydrostatically from superstructure cab.

Carrier cab Two-man full width cab of composite (steel sheet metal and fibre-glass) structure, with safety glass, air-cushioned adjustable seats (driver seat with heater) and engine dependent water heater, air conditioning, radio/CD-player, complete controls and instrumentation for road travel. Cruise control with hill breaking feature functions.

Electrical system 24 volt DC system, 2 batteries, outrigger area lighting. Electrical system conforms with European standard regulations.

Optional Equipment (at extra charge)

Towing attachment, engine independent additional cab heater with engine pre-heat, 8 x 8 drive, 525 / 80 R 25 (20.50 R 25) tires, spare wheel and tire, special painting and lettering.

Further optional equipment available upon request.

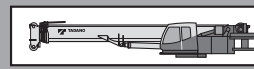

Frame Torsion-resistant, all-welded structure of high strength steel. Connected to carrier by single-row ball bearing slewing ring with external gearing for 360° continuous rotation. Central lubricating system.

Superstructure engine Mercedes-Benz 4 cylinder model OM 934 LA (Euromot IV b/EPA Tier 4f), water-cooled, diesel engine. RPM infinitely variable via foot pedal, Rated at 175 HP (129 kW) at 2,200 rpm. Torque 553 ft-lbs (750 Nm / 76 kpm) at 1,200 - 1,600 rpm. Engine rating according to ECE R 120. Fuel tank 58 gal (220 l). DEF Tank 2.6 gal (10 l).

Hydraulic system Three circuit diesel hydraulic system with 1 power controlled double axial piston pump (electrically adjustable), 1 axial piston pump and 2 gear pumps, oil cooler.

Controls Electrical, 2 joy-stick levers for simultaneous operation of crane motions.

Telescopic boom 6 sections, made of high tensile, fine-grained steel, consisting of 1 base section and 5 telescoping sections extended by means of a single telescopic cylinder. All telescope sections extendable under partial load. 36.4 ft (11.1 m) to 168.0 ft (51.2 m) long. Boom head with 7 sheaves.

Derricking system 1 double acting hydraulic cylinder with integral brake and holding valve.

Main winch Axial piston motor, winch drum with integrated planetary reduction and hydraulically controlled spring loaded, multiple disc brake and integrated free rotation (no sagging of load when hoisting). Hoist cable with 'Super-Stop' easy reeving system.

Slewing system Axial piston motor with two-stage planetary gear equipped with a foot actuated service brake and a parking brake. Speed infinitely variable 0 - 2.0 rpm.

Counterweight Standard 13,228 lbs (6,0 t) divisible, assembled and disassembled by hydraulic cylinders controlled from superstructure cab.

Superstructure cab Spacious panoramic cab of composite structure with safety (tinted) glass windows, tiltable cockpit with hydraulically cushioned adjustable seat with heater, engine independent water heater with engine pre-heat, air conditioning, radio/CD-player. Complete controls and instrumentation for crane operation, on-site travelling and outriggers.

Electrical system 24 volt DC system, 2 batteries.

Safety devices Load moment device (LMD), incl. asymmetrical outrigger base, working area limiter, hoist limit switch, lower limit switch and drum turn indicator, anemometer, safety valves against pipe and hose rupture, holding valves on hydraulic cylinders.

Optional Equipment (at extra charge)

'Lift Adjuster', Boom extensions 32.8 ft (10.0 m) / 59.0 ft (18.0 m), offsets 0°, 20° and 40° or hydraulically 0°- 40°, heavy duty jib 5.2 ft (1.6 m). Additional counterweight 36,376 lbs (16.5 t), counterweight variations 0 lbs (0 t) / 11,243 lbs (5.1 t) / 13,228 lbs (6.0 t) / 16,755 lbs (7.6 t) / 22,487 lbs (10.2 t) / 35,935 lbs (16.3 t) / 49,604 lbs (22.5 t), selection of hook blocks, auxiliary winch, slewing area limitation, additional oil cooler, special painting and lettering.

Further optional equipment available upon request.

Equipo



Chasis portante Construcción de acero de alta resistencia soldado, resistente a la torsión y a la flexión. Sistema de engrase central.

Estabilizadores Estabilizadores hidráulicos de 4 puntos incl. detección de longitud automática y posibilidad de manejo desde ambos lados del chasis portante y desde la cabina de la grúa. Extensión de los estabilizadores: 7,2 m (y 5,0 m) x 8,5 m.

Motor Mercedes-Benz modelo OM 470 LA (Euromot IV / EPA Tier 4f), 6 cilindros, diesel, refrigerado por agua. Nominal 320 kW (435 CV) a 1700 min⁻¹. Par 2100 Nm a 1300 min⁻¹. Potencia del motor según ECE R 120. Depósito de combustible de 400 l. Depósito AdBlue 40 l.

Transmisión Transmisión mecánica tipo ZF-AS Tronic modelo 12 AS 2531 con intarder integrado, accionamiento electro-neumático embrague en seco y cambio automático, 12 marchas delanteras y 2 marchas traseras.

Transmisión Caja de distribución (transfer) con 2 relaciones de velocidad.

Tracción 8 x 6 (8 x 8 como opción*)

Ejes

- 1º eje: de dirección, no accionado
- 2º eje: de dirección, accionado, con bloqueo diferencial transversal.
- 3º eje: de dirección, accionado, con bloqueo diferencial transversal y longitudinal.
- 4º eje: de dirección, accionado, con bloqueo diferencial transversal.

Suspensión Suspensión hidroneumática con regulación de nivel.

Sistemas de frenos Sistema de frenos de disco neumático de doble circuito con Sistema anti bloqueo ABS. Freno de estacionamiento del tipo freno de muelle, accionando sobre los ejes 2o, 3o y 4o. Intarder y freno motor como freno continuo.

Neumáticos (8) 445 / 95 R 25 (16.00 R 25), (ancho 2.75 m).
(8) 525 / 80 R 25 (20.50 R 25), (ancho 2.97 m).

Dirección Hidráulica ZF Servocom de doble circuito. Dirección mecánica del 1o y 2o eje y direccionable del 4o eje hasta una velocidad de 25 km/h, con asistencia hidráulica, con bomba hidráulica de emergencia. Dirección de todos los ejes posible. Desde la cabina de la superestructura: dirección hidro-estática de todos los ejes.

Cabina Cabina avanzada para dos personas, en construcción de acero y fibra de vidrio. Cristales de seguridad, asientos con suspensión neumática, asiento de conductor calefactado. Calefacción por agua caliente del motor, climatización, radio / CD-player. Elementos de control y manejo para circular por carretera. Regulador de velocidad, sistema automático de frenado.

Sistema eléctrico Sistema de 24 V c.c. con dos baterías, faros de trabajo en los estabilizadores. El sistema eléctrico cumple la normativa CE.

Equipo adicional (con suplemento de precio)
Embrague de remolque, calefacción adicional con precalentamiento del motor, tracción 8 x 8, neumáticos 525 / 80 R 25 (20.50 R 25), rueda de repuesto, pintura especial y rotulación.

Otros equipamientos sobre pedido.

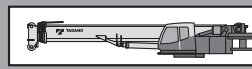

Superestructura Construida en aceros soldados, resistente a la torsión. Corona de giro con rodamiento de una fila de bolas con dientes externos para giro continuo a 360°. Sistema de engrase central.

Motor Mercedes-Benz modelo OM 934 LA (Euromot IV / EPA Tier 4f) 4 cilindros, diesel, refrigerado por agua. Las revoluciones aumentan de forma gradual accionando el acelerador. Nominal 129 kW (175 CV) a 2200 min⁻¹. Par 750 Nm a 1200 - 1600 min⁻¹. Potencia del motor según ECE R 120. Depósito de combustible de 220 l. Depósito AdBlue 10 l.

Sistema hidráulico Sistema dieselhidráulico de 3 circuitos, 1 bomba doble de pistones axiales de caudal variable (regulable eléctricamente) una bomba de pistones axiales y 2 bombas en tandem, enfriador de aceite.

Mandos 2 palancas de control de tipo joy-stick para movimientos simultáneos de la grúa (4 direcciones), asistidas eléctricamente.

Pluma telescópica 6 secciones, un tramo base y 5 telescópicos de acero de alta resistencia soldado, 1 cilindro hidráulico, los tramos se pueden telescopar hidráulicamente bajo carga. Longitud de 11,1 m a 51,2 m. Cabeza de pluma con 7 poleas.

Elevación de pluma Mediante un cilindro diferencial, con válvula de bloqueo de frenado de descenso integrada.

Cabrestante principal Motor hidráulico de pistones axiales y caudal fijo. Tambor del cabrestante con reducción planetaria y frenos de disco múltiples accionados, con sistema libre de elevación. Cable de elevación con sistema fácil de guiado y 'Super-Stop'.

Sistema de giro Motor hidráulico de pistones axiales con reducción planetaria de dos etapas. Freno de servicio controlado por pedal y freno de estacionamiento. Velocidad de giro variable de 0 a 2,0 min⁻¹.

Contrapeso El estándar 6,0 t divisible, se acciona desde la cabina de la grúa.











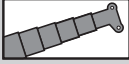
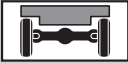
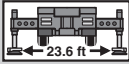
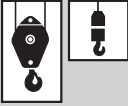



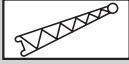

Cabina de la grúa Cabina espaciosa y confortable, en construcción de acero y fibra de vidrio, con cristales tintados de seguridad. Asiento de operador regulable amortiguado mecánico, inclinable junto con los instrumentos y mandos, asiento calefactado. Calefacción independiente del motor y precalentamiento del motor, climatización, radio / CD player. Controles, instrumentos y mandos de conducción para la operación de la grúa y para el desplazamiento en obra. Mandos para nivelación y extensión de los estabilizadores.

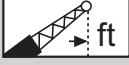
Sistema eléctrico Sistema de 24 V c.c. con dos baterías.

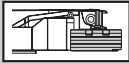
Medidas de seguridad Limitación del momento de carga (LMC), incl. base de apoyo asimétrica, limitación del área de trabajo, interruptor final de elevación, interruptor de 3 últimas vueltas en cabrestante, indicador de bajada o subida del cable del cabrestante, anemómetro, válvulas de seguridad para rotura de tubos y latiguillos. Válvulas de retención en los cilindros hidráulicos.

Equipo adicional (con suplemento de precio)
'Lift Adjuster', plúmín de 10,0 m / 18,0 m regulable hidráulicamente de 0°, 20° y 40° (o hidráulicamente 0° a 40°), plúmín de carga pesada de 1,6 m, contrapeso adicional de 16,5 t, variantes de contrapeso 0 t / 5,1 t / 6,0 t / 7,6 t / 10,2 t / 16,3 t / 22,5 t, selección de ganchos, 2º cabrestante, limitador de giro, enfriador de aceite adicional, pintura especial y rotulación.

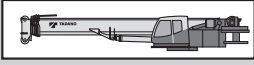
Otros equipamientos sobre pedido.

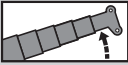
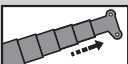
 445/95 R 25 (16.00 R 25)	Tires / Size Neumáticos / Tamaño de ruedas		Telescopic boom Pluma telescópica
	Axle load Carga por eje		Outriggers Estabilizadores
	Hook block / Swivel hook Gancho / Gancho de bola	49,604 lbs	Counterweight Contrapeso
V+ 	Carrier speeds Velocidades del chasis		Radius Radio
	Transmission / Gear Transmisión / Marchas		Boom extension Plumin
	Gradeability Superacion de pendientes		Boom extension hydraulically Plumin hidráulicamente
	Off road Todo terreno		Radius Radio
	On road En carretera		Counterweight versions Variaciones de contrapeso
V+ 	Superstructure speeds Velocidades de la superestructura		Carrier chasis
	Main winch Cabrestante principal		Superstructure superestructura
	Auxiliary winch 2° cabrestante	SAE	The data are for basic information only and the operator's manual must be consulted before operating this crane. All data and performances refer to the standard crane. The addition of optional and other equipment may affect the performance of the crane.
	Slewing system / hydraulically locked Sistema de giro / Embulonamiento hidráulico		
	Derricking system Elevación de pluma		
	Boom telescoping Telescopaje de pluma		Los datos sirven solamente para su información. Hay que leer las instrucciones para el uso antes de la puesta en servicio de la máquina. Todos los datos mencionados en las presentes tablas rigen para los modelos standard. Cualquier modificación del equipo montado puede dar lugar a modificaciones de aquellos valores.

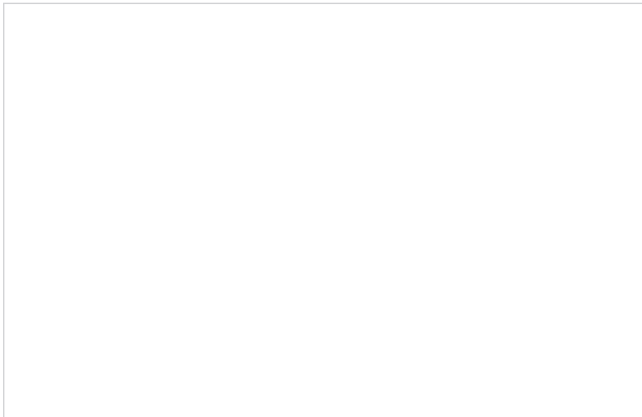

TADANO AMERICA Corporation
4242 West Greens Road, Houston, TX 77066
Phone: 281-869-0030 Fax: 281-869-0040
www.tadanoamerica.com E-mail: tac.sales@tadano.com
Parts Hotline: 281-869-0033 Service Hotline: 281-869-5925